



R&D SOP095 Laboratory Biological Safety Cabinet

## Document Title: Laboratory Biological Safety Cabinet

Document Number: R&D SOP095

<b>Staff involved in development:</b> <i>Job titles only</i>	Senior R&D Manager, Tissue Bank team leader Clinical Project Managers and Research Pathology
<b>Document author/owner:</b>	Senior R&D Manager
<b>Directorate:</b>	Research and Development
<b>Department:</b>	Research and Development
<b>For use by:</b>	NHS Staff Trust-Wide
<b>Review due:</b>	January 2027
<p><b>THIS IS A CONTROLLED DOCUMENT</b></p> <p>Whilst this document may be printed, the electronic version maintained on the Trust's Intranet is the controlled copy. Any printed copies of this document are not controlled. ©Royal Papworth Hospital NHS Foundation Trust. Not to be reproduced without written permission.</p>	

### Summary of Amendments

Version Number	Modification:
1.0	

## R&amp;D SOP095 Laboratory Biological Safety Cabinet

**Key Points of this Document**

- This document sets out the procedures to be followed by all Royal Papworth staff who use biological safety cabinets for processing of clinical samples.
- It provides guidance on safe operation and maintenance of biological safety cabinets accessible to Royal Papworth staff.
- Staff are expected to follow procedures outline to reduce the risk of infection to staff and to ensure samples are not contaminated.

**1 Purpose and Contents**

- a. Biological Safety Cabinet (BSC) is designed to protect the operator, the laboratory environment and work materials from exposure to infectious aerosols and splashes that may be generated when manipulating substances containing infectious agents, such as viruses, bacteria and primary tissue cultures. The principle behind this is to provide airflow that protects the user from the samples as well the samples from contamination. The hood should only be used with a stable airflow, indicted by the control panel.
- b. Papworth laboratories are unable to process higher risk samples such samples from COVID positive patients or unscreened cytology samples.
- c. The BSC are not intended to filter vapours containing acids or organic solvents. The BSC MUST not be used as a fume hood.
- d. This document details the procedures for using BSCs for processing clinical samples collected as part of a clinical research projects.
- e. The BSC hood in Papworth mini-lab has only one Hepa Filter and therefore only low risk samples should be processed within this hood (blood, urine, pleural fluid) (see Appendix A for detailed user instructions).

**2 Roles & Responsibilities**

- a. This Policy applies to all personnel who are conducting research at the Trust.

## R&amp;D SOP095 Laboratory Biological Safety Cabinet

- b. The BSC may only be used by staff members that have been trained to use it. Staff members who use the BSC must also assist with the daily, weekly and monthly maintenance of the cabinet.
- c. Training in this procedure will be carried out by a competent member of staff. There will be a period of supervision (the length of time depending on the individual being trained) followed by an assessment of competency. Assessment will take the form of a quality check of the material produced. All new users must be signed off as competent by a trained member of staff before using the BSC independently.

### 3 Policy

- a. This SOP is mandatory and, as per the Trust's Information Governance and Records Management framework, non-compliance with it may result in disciplinary procedures.

### 4 Procedure

#### 4.1 Using a Biological Safety Cabinet- Aseptic technique.

- a. A BSC is a closed system where the air circulates around and is filtered by a Hepa filter. It is important not to introduce any contaminants into the BSC.
- b. Objects and appliances must be carefully cleaned or disinfected before being introduced into the work chamber. Do not bring in writing utensils, packing material, etc.
- c. Only have the equipment and consumables you need when operating, as too many items in the cabinet can impede the airflow. Never block the front or rear grill as it will prevent efficient airflow.
- d. Gloves and laboratory coat must be worn when using the BSC.
- e. Before working in the BSC, turn it on and ensure the air flow is stable. (Normally takes 5min).
- f. Ensure that the window of the BSC is at the correct height for the airflow to be stable. In the HLRI Clinical Research Facility (CRF) the window open button will automatically open the window to the correct height. Turn on the light. In the mini lab in RPH outpatients there is a black line to indicate where the window should be.
- g. If using media, ensure it is clear and not cloudy.

## R&amp;D SOP095 Laboratory Biological Safety Cabinet

- h. Use an ethanol spray/ or Clinell wipe to clean the inside of the BSC.
- i. Test tube and sample racks should be removed and cleaned with ethanol spray and towel or Clinell wipe.
- j. If biohazard such as blood is spilt on equipment it should be soaked in Tristel or bleach solution, rinsed with water and then dried (see SOP 0124).

## 4.2 Cleaning/ Disinfecting

### 4.2.1 Products used will depend on area / use of the BSC

- a. Mini lab (within Royal Papworth Hospital)- Clinell wipes
- b. CRF Laboratory- 70% IDA Clinell wipes may also be used (alcohol spray laboratory)
- c. CRF Drug preparation- Klercide 70/30 Spray (alcohol spray pharmacy)
- d. Tristel or Bleach from the biohazard kit may also be used when samples have been split. (These products must be removed after a couple of minutes with alcohol spray or Water.)

### 4.2.2 Spills (see SOP 124)

- a. Spills must be cleaned up immediately, especially if it is a biohazard.
- b. Small spills can be with an ethanol spray and towel, or Clinell wipe.
- c. For larger spills bleach granules in the biohazard kit may be used to absorb the liquid. If necessary, clean underneath the metal panels (make sure the airflow is switched off before removing the panels.). After cleaning switch on the U.V. light and allow it to run for at least twenty minutes.
- d. Biohazard material should be disposed of in clinical waste.

### 4.2.3 Cleaning Schedule

On the side of each BSC there is a cleaning schedule. Before cleaning make sure that the air flow is switched off, as towels can get sucked up and damage the filter.

## R&amp;D SOP095 Laboratory Biological Safety Cabinet

**4.2.4 Weekly Clean**

- a. Run the BSC UV light once a week. Over time UV light can make plastic brittle so make sure that all pipette boxes are closed and racks are removed. The window of the BSC must be fully closed before turning on the UV light.
- b. Clean all pipettes located in the BSC by wiping clean with towel sprayed with alcohol spray or Clinell wipe.

**4.2.5 Monthly Clean (weekly in Drug preparation room)**

- a. Run the BSC UV light first.
- b. Open the BSC window door without turning on the airflow. Only essential items should be kept in the BSC. Move all items to one side to allow you to clear the metal panel.
- c. Use ethanol spray/ Clinell wipe to clean the metal panels. Remove the metal panel to allow you to clean on the other side of the panel and underneath the panel.
- d. If there is sign of sample residue use Tristel/ Bleach solution to disinfect. Leave for no more than 3min and then remove with ethanol spray and towel/ or Clinell wipe.
- e. After one side of the BSC is cleaned replace the metal panel and move other items to clean the other side.
- f. Use ethanol spray to clean in inside side panels and the window, or hand soap/water with a paper towel. **Do not use Clinell wipe on the window as this leaves a residue.**

**4.3 Environmental Monitoring**

- a. When BSC hood in drug preparation room is in use it will have regular checks for sterility. See BSC Environment Monitoring Guidance.

**4.4 Preventive Maintenance**

- a. BSC in Papworth Hospital: Preventive maintenance is carried out every year by an external company (CHTS) contracted by the Trust to perform this function.
- b. BSC in CRF: Cambridge university is responsible for regular service and air flow checks.

R&D SOP095 Laboratory Biological Safety Cabinet

## 5 Health and Safety

### 5.1 COSHH

Staff members must read all COSHH forms related to chemicals used to clean these BSC include:

Chemicals in biohazard cleaning kit- Haz -Tab- chlorine releasing disinfectant granules and tablet

Tristel duo and Tristel fuse

Clinell wipes

70% ethanol (alcohol)

Klercide 70/30 Spray

## 6 Risk Management / Liability / Monitoring & Audit

- a. The R&D SOP Committee will ensure that this SOP and any future changes to this document are adequately disseminated.
- b. The R&D Department will monitor adherence to this SOP via the routine audit and monitoring of individual clinical trials and the Trust's auditors will monitor this SOP as part of their audit of Research Governance. From time to time, the SOP may also be inspected by external regulatory agencies (e.g., Care Quality Commission, Medicines and Healthcare Regulatory Agency).
- c. In exceptional circumstances it might be necessary to deviate from this SOP for which written approval of the Senior R&D Manager should be gained before any action is taken. SOP deviations should be recorded including details of alternative procedures followed and filed in the Investigator and Sponsor Master File.
- d. The Research and Development Directorate is responsible for the ratification of this procedure.



R&D SOP095 Laboratory Biological Safety Cabinet

Further Document Information

<b>Approved by:</b> <i>Management/Clinical Group</i>	<i>Directorate</i>	Research and Development Directorate					
<b>Approval date:</b> <i>(this version)</i>	Current approved version date						
<b>Ratified by Board of Directors/ Committee of the Board of Directors:</b>	STET						
<b>Date:</b>	N/A						
<b>This document supports:</b> <i>Standards and legislation</i>	Medicines for Human Use (Clinical Trials) Regulations 2004 and all associated amendments. UK Policy Framework for Health and Social Care Research (2018)						
<b>Key related documents:</b>	Trust Research Policy DN180 -Needlestick Sharp and Splash Incidents involving blood or body fluids Procedure DN298 Medical Devices Maintenance and Repair Procedure						
Equality Impact Assessment: Does this document impact on any of the following groups? If YES, state positive or negative, complete Equality Impact Assessment Form available in Disability Equality Scheme document DN192 and attach.							
<b>Groups</b>	Disability	Race	Gender	Age	Sexual orientation	Religious & belief	Other
<b>Yes/No</b>	NO	NO	NO	NO	NO	NO	NO
<b>Positive/Negative</b>							
<b>Review date:</b>	DATE						

I certify the contents of this SOP has been reviewed and ratified

*Patrick Calvert*

15-02-2024

.....  
Signed by Dr Patrick Calvert, Clinical Director of R&D

.....  
Date

SOP Release Date: .....

R&D SOP095 Laboratory Biological Safety Cabinet

## Appendix A:

### User instruction for BSC in Outpatients mini-lab

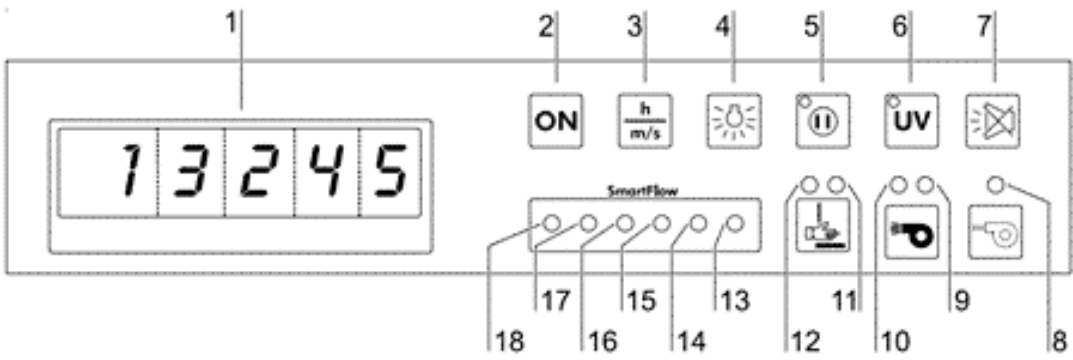

1	Press to switch on / off
2	Shows Operating hours, downflow and exhaust air velocities in the safe work mode.
3	Switch on and off
4	Press to switch power supply outlets on and off
5	UV disinfection on and off (the yellow light is on)
6	Button to turn off alarm
7	Yellow-reduced air flow capacity
8	Red-air flow not steady
9	Green- airflow steady
10	Front window is not in work position (the red light)
11	Front window is in work position (the green light)
12	Front window is in work position (the green light)
13-18	SmartFlow display
18 green + 17 green	sufficient compensation capability
16 yellow + 15 yellow	[compensation capability is depleted
14 red + 13 red	window outside working position or air velocity outside alarm range

### Sample chamber access

The front window is manually movable

#### Work position = A

- e. Should be opened to A when working in the BSC.



R&D SOP095 Laboratory Biological Safety Cabinet

- f. The BSC will alarm if the window is not at the correct height when in use- see operation panel

**Maximum opening height =B**

- g. Can be opened to this height if required during cleaning

**Closed position = C**

- h. Keep BSC closed when not in use or when using U.V. light

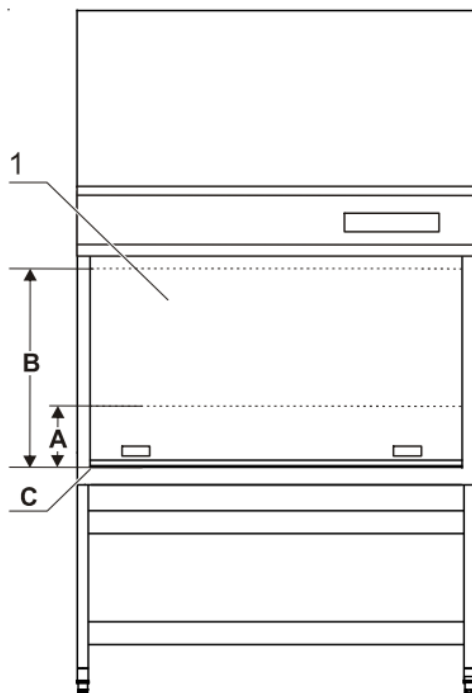

### Opening the BSC

1. Approximately 15 minutes before any work in the cabinet, the BSC should be switched on and the window opened.
2. Switch the device on, keep the ON key [2] depressed until:
  - the blowers start (audible blower operation),
  - the status indicators (LEDs) [9] - [12] illuminate.
3. The front window is manually positioned in working position and kept in that position during the entire work process.
4. Wait until the green status indicator AIRFLOW IS STEADY [10] is illuminated.

## R&amp;D SOP095 Laboratory Biological Safety Cabinet



**BSC in standby mode**

- i. The front window can be lowered to seal the sample chamber.
- j. The BSC can be switched off (in OFF mode): by holding down the On key until all indicators are off.



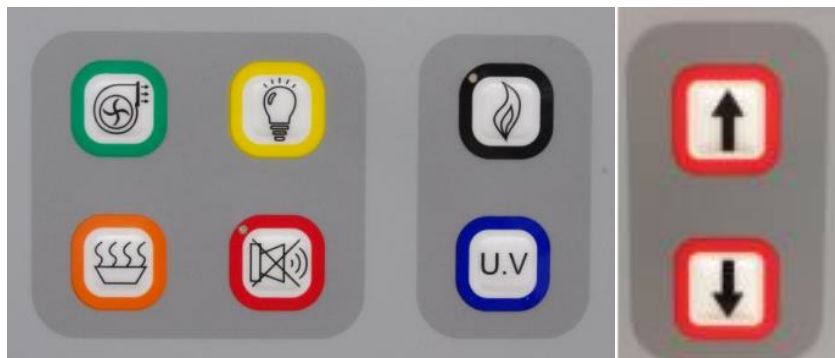



**Using UV mode**

- k. Press the UV on/off button the yellow light turns on.
- l. UV lamps are switched off automatically at after an hour
- m. When the front window is opened, the UV disinfection routine is cancelled immediately.

**Control Panel**

DESCRIPTION	LEGEND	COLOUR	FUNCTION
A – Cabinet Operation Starts /		Green	Stops power supply to fans and control circuits.
B – Lights		Yellow	Controls power to work area lighting.
C – Gas Valve (Optional Feature)		Black	Used to activate a solenoid Gas Valve (if fitted). Will only function when cabinet airflows are in a safe working condition.

## R&amp;D SOP095 Laboratory Biological Safety Cabinet

D – Alarm Mute		Red	To mute the audible alarm. Fault indication on display will remain lit until fault is rectified, red alarm strip bar mounted in the bottom of the control panel door works in conjunction with the visual alarm.
E – Fumigate		Orange	To activate decontamination cycle. Will only operate when cabinet is switched OFF and visor is closed. (can be configured to formaldehyde or VHP)
F – UV Lights (Optional Feature)		Blue	Used to activate power to UV Lights. Will only operate when cabinet is switched OFF, interlocked with cabinet lights.
G – Lock Function When pressed it will request a lock number, this is 8860		On TFT Display (Touch screen) Shown locked.	Lock facility for supervisor & maintenance engineer control, used to prevent cabinet operation during decontamination or otherwise.
UP Arrow		Red Border	Used to drive the front sash open
DOWN Arrow		Red Border	Used to drive the front sash close

**Switching on**

- n. Ensure power supply to the cabinet is switched on. The key is located at the top left front of the cabinet must be turned to position 1 (ON).
- o. Press the green switch on the control panel. This will switch on the exhaust fans and the down flow fans.
- p. On start-up, an audible alarm will sound until airflow is stable and safe. This may be muted using the red 'alarm mute' button.
- q. To switch on the interior lighting, use the yellow light switch button.
- r. Lighting can be activated when the cabinet is OFF.

R&D SOP095 Laboratory Biological Safety Cabinet

**Appendix B - BSC Risk Assessment -**

<p><b>Description of Activity</b></p> <p>A Biological hood is used to safely handle potentially infectious material from patient samples. Fresh tissue may also be handled within the hood.</p>	<p><b>Significant Hazards</b></p> <ul style="list-style-type: none"> <li>• Chemical</li> <li>• Biological</li> <li>• Physical</li> <li>• Ergonomic</li> </ul>
<p><b>Frequency:</b> Daily</p>	<p><b>Duration:</b> used up to 2 hours</p>
<p><b>Adverse Effects</b></p> <ul style="list-style-type: none"> <li>• Exposure to potentially infectious material and chemicals if there is failure with air flow.</li> <li>• Potential exposure to UV light which could cause damage to skin and eyes if it is not working properly.</li> <li>• Hands could get trapped when closing the window of the hood.</li> </ul>	<p><b>People at Risk</b></p> <ul style="list-style-type: none"> <li>• Research team</li> <li>• Clinical Trial Co-ordinator</li> <li>• Tissuebank staff</li> </ul>
<p><b>Number of People Affected:</b></p>	<p><b>Operator and Any members of Staff present in Area</b></p>
<p><b>What Precautions exist to control the risk:</b></p> <ul style="list-style-type: none"> <li>• Wear proper protective equipment (gloves, lab gown and goggles).</li> <li>• Staff members must be trained and competency signed off before using BSC.</li> <li>• Report any damage to the person in charge of centrifuge.</li> <li>• To know the location of eyewash stations and safety showers.</li> <li>• In case of centrifuge breakage and there is skin contact with spillage or sharps injury; Occupational health (M-F 9am-5pm) or ALERT team (bleep 432/521) <b>MUST</b> be notified.</li> <li>• The biological hood is serviced annually to ensure that the air flow and the UV light working properly. To limit exposure to infectious material personal protective equipment (gloves and laboratory coat) are used while using the hood.</li> <li>• The hood is deep cleaned weekly/monthly with antibacterial cleaning agent.</li> <li>• <b>BSC in royal Papworth is only classed as at Category 1, only low risk samples should be processed in this hood.</b></li> </ul> <p><b>Risk Rate:</b></p>	

R&amp;D SOP095 Laboratory Biological Safety Cabinet

<b>Likelihood 1</b>	<b>Severity 1</b>	<b>RRN 1</b>	<b>H S M L N</b>
<b>Are these arrangements satisfactory: Yes</b>			

<b>RISKS IDENTIFIED: Hazard Classification.</b>				
<b>Risk type</b>	<b>Description of Risk</b>	<b>Precautions/ controls</b>	<b>Likelihood/Severity</b>	
			Score 1-5 1= minimum 5= maximum	
Chemical	Clinell wipes, IDA and Tristel used to clean biological hood.	Gloves, laboratory coat	Likelihood = L Severity = S Risk Rating = LxS Sufficient controls Y or N	1 1 1
Biological	Exposure to infective agents if the air flow fails	Cabinet is serviced annually to make sure there is correct air flow.  Gloves and laboratory coat to be worn while working within the cabinet to limit exposure risk	Likelihood = L Severity = S Risk Rating = LxS Sufficient controls Y or N	1 1 1
Ergonomic	Hand trapped while closing the hood	Keep hands away when closing the hood	Likelihood = L Severity = S Risk Rating = LxS	1 1 1

## R&amp;D SOP095 Laboratory Biological Safety Cabinet

			Sufficient controls Y or N	
Physical	Exposure to UV light. Burns to eyes and skin.  Blindness, burns	Cabinet equipped with safety switch that prevents UV light from being activated while cabinet is open	Likelihood = L  Severity = S  Risk Rating = LxS  Sufficient controls Y or N	1  1  1
Ergonomic	Working at an awkward angle when dealing with samples	Adjustable bench. Shift position whenever possible.	Likelihood = L  Severity = S  Risk Rating = LxS  Sufficient controls Y or N	1  1  1